

Thank you for purchasing a Shakespeare antenna product. Customer comments are welcome. Before installing, please study the diagram and check parts supplied against those listed.

IMPORTANT! Please read all instructions before installing.

The Style 410-R Mounting Kit is a versatile antenna mounting kit comprised of a Shakespeare Style 81-S Swivel Mount and a Shakespeare Style 408-R Standoff Bracket. The dual swivel mount permits mounting on vertical or horizontal surfaces. For use with 1/2" antennas, and antennas of 1/8" and 1" diameter by using the appropriate adapter (supplied) in the standoff bracket.

Tools required: Drill and drill bit for 1/4" screws; screwdriver; wrench or pliers

Installation Instructions

Choose an antenna mounting location that is as high as feasible, as free as possible from obstructions, and as far as possible from other antennas and strong sources of RF.

1. Using the base of the Swivel Mount as a template, mark the location for the four mounting holes. Drill 1/4" holes.
Note: When drilling fiberglass, place a wooden backup block behind the surface if possible, to minimize push-through damage.
2. Attach the Swivel Mount to the mounting surface using hardware (sold separately) that is applicable to the mounting surface.
3. Assemble the antenna to the Swivel Mount, being careful not to damage the antenna's cabling, if any.
4. Loosen the wing nut on top of the Standoff Bracket and slide the retainer bar out of the way. Gently place the antenna in its mounting position in the U-shaped opening in the bracket. For 1/8" and 1" antennas, put the appropriate reducing adapter (supplied) in the opening.
5. Rotate the retainer bar over the antenna to lock it in place.
6. Using the Standoff Bracket itself as a template, mark the position for its mounting holes.
7. Drill 1/4" mounting holes, and install the bracket using stainless steel hardware appropriate to the mounting surface (hardware sold separately).
8. Tighten the wing nut to secure the antenna in the bracket. The completed installation should attach the antenna firmly to the mounting surface, leaving no "play" between the antenna and the standoff bracket.

IMPORTANT: If the thickness of the mounting surface is not adequate to support the antenna under expected stress, a wooden back-up pad (not supplied) should be applied underneath the mounting surface during installation.

Supplied Parts	
1	Swivel Mount assembly
1	Standoff Bracket assembly
1	1" Reducing adapter
1	1 1/8" Reducing Adapter

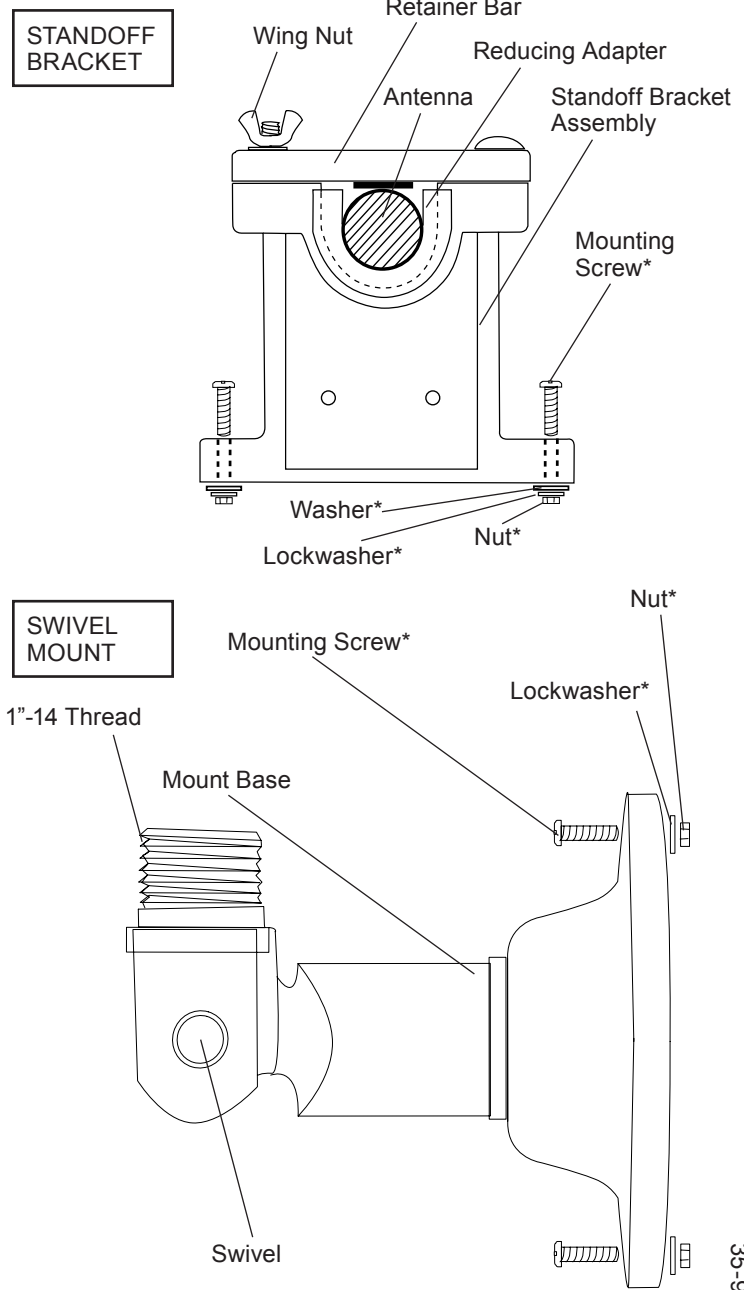

* Not supplied. For some types of mounting surfaces you might need stainless steel woodscrews or other hardware.

35-90-1268-00

Shakespeare Electronic Products Group

U.S. Operations: 6111 Shakespeare Rd. · Columbia, SC 29223 · 803-227-1590 · Fax: 803-419-3099 · www.shakespeare-marine.com
 U.K. Operations: Enterprise Way, Fleetwood, Lancashire, FY7 8RY, England · +44 (0) 1253 858787 · Fax: +44 (0) 1253-859595 · www.vtronix-antennas.com