

Commander HYDRAULIC STEERING FOR OUTBOARD MOTORS & STERNDRIVES

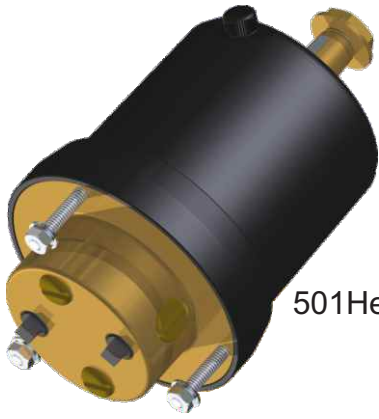

501Helm unit



512T Cylinder construction
Anodised marine aluminium
and Stainless steel

COMKIT-SPORT

For Outboards up to single maximum 135HP (optimum 90hp) or dual outboards Counter-rotating up to 250HP total

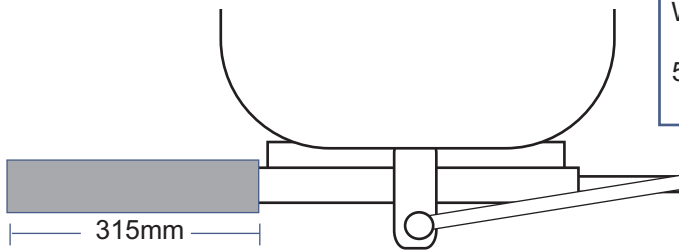

Model 512T Cylinder dimensions

Capacity:- 77cc
Stroke:- 203mm
Weight:- 2Kg

WHEEL TURNS
lock to lock
501 helm = 2.75

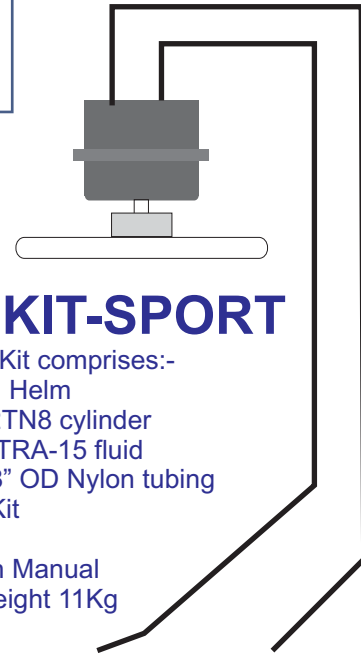

COMKIT-SPORT

Complete Kit comprises:-
Model 501 Helm
Model 512TN8 cylinder
2 litres ULTRA-15 fluid
15Mtrs 3/8" OD Nylon tubing
Bleeding Kit
All fittings
Installation Manual
Packed weight 11Kg

SIMPLE INSTALLATION TO ANY OUTBOARD**
See steering circuits for multiple outboards and catamaran installation options.

**Unit designed to be used with standard outboard motor drag-link supplied with the engine. Not included in the kit as each outboard manufacturer and model has different drag-link design..

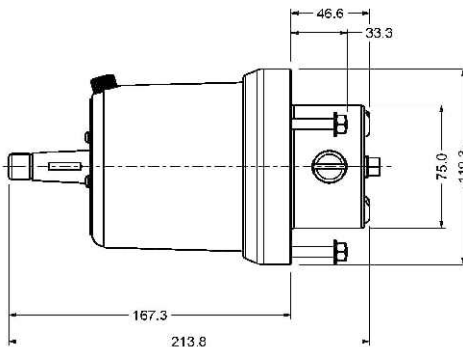

Model 501 HELM DIMENSIONS

Model 501 Capacity:-28cc/rev
In-built Lock valve
Maximum working pressure:- 800psi
Absolute maximum pressure:- 1000psi
Weight:- 5Kg

See also optional helm choices for front-mount and tilting helms for this kit

